

SERIE

HST DESIGN TOP TERMIC

SCORREVOLE ALZANTE

Grandi vetrate con
 profilo ridotto per alte
 prestazioni termiche
 e maggiore luminosità.

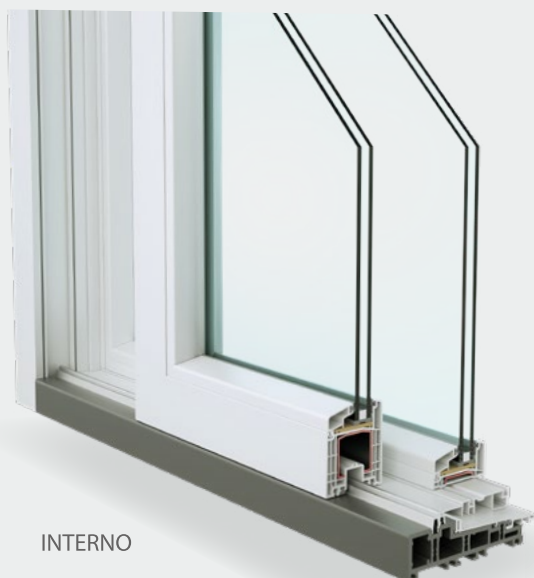

INTERNO



ESTERNO

TRASMITTANZA TERMICA

 NODO MEDIO (Uf) **1,30 W/m² K**

- * Profilo a vista ridotto del 50% per una maggiore luminosità e un design moderno
- * Rinforzi in acciaio zincato in massa di spessore adeguato e di notevoli dimensioni
- * Vetrocamera certificati ad alto isolamento termico ed acustico con canalina warm-edge
- * Adatto al montaggio di vetri tripli fino a 54 mm di spessore
- * Vasta gamma di finiture
- * Prodotto 100% Made in Italy

Verifiche a cui è stato sottoposto il sistema

VERIFICA	RISULTATO DELLA VERIFICA
Verifica di idoneità in conformità a RAL-GZ-716-1	Permeabilità all'aria conforme a DIN EN 12207: classe 4 Resistenza alla pioggia battente conforme a DIN EN 12208: classe 9A
Verifica isolamento termico	Coefficiente di trasmittanza termica Valore U_f medio= 1,30 W/m ² K

HST DESIGN TOP TERMIC . Nodi

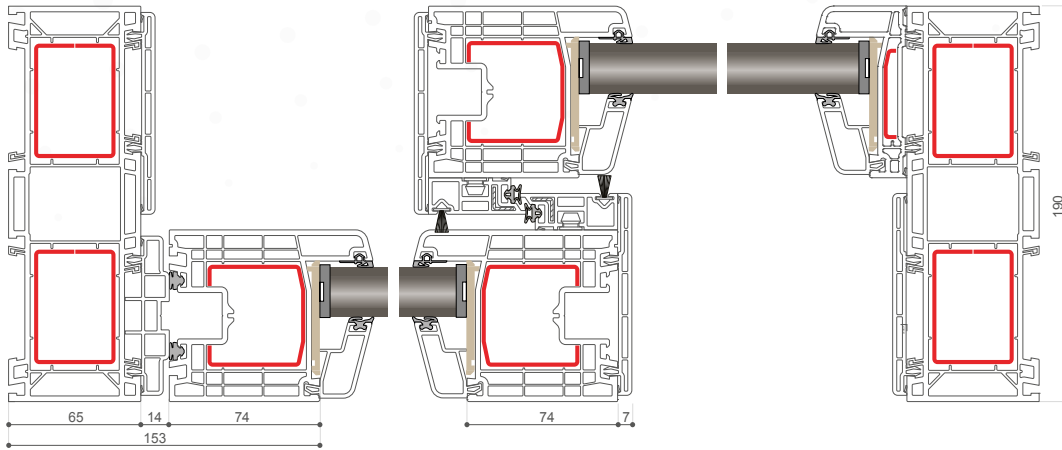

Telaio

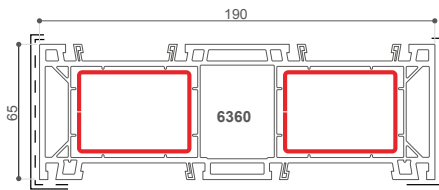

Soglia T.T.

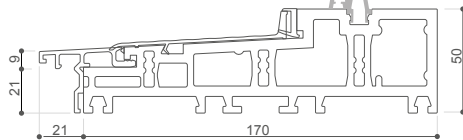

Soglia T.T.R.

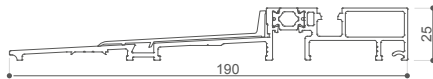

Anta

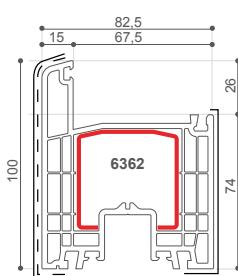

Anta Design

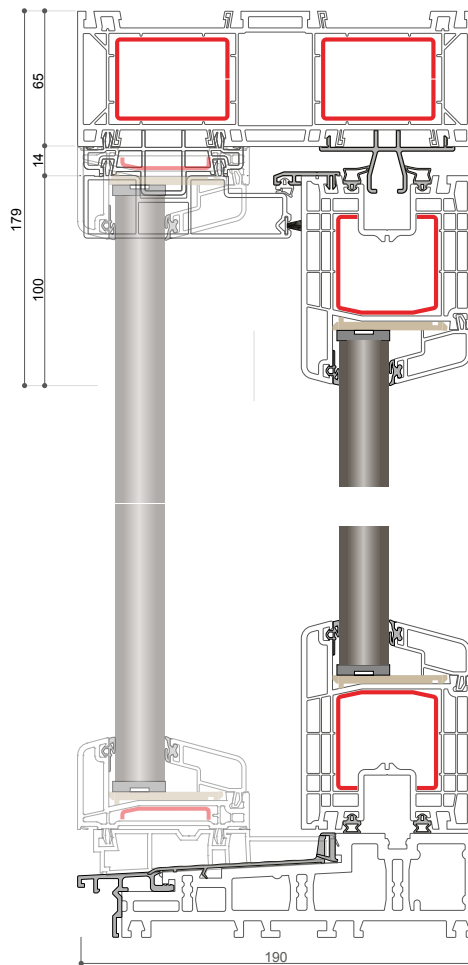
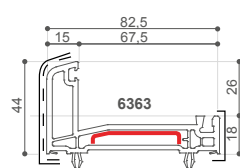

HST DESIGN TOP TERMIC . Colori

COLORI MASSA



bianco 00

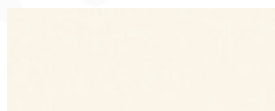

avorio 06

RIVESTIMENTO TIPO A



golden oak 2178001

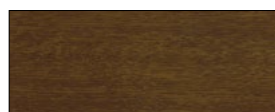

noce golden 2178007

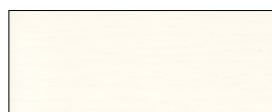

bianco legno 915205

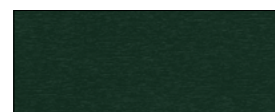

verde scuro 612505



douglas chiaro 3069041

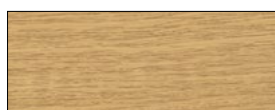

rovere naturale 3118076

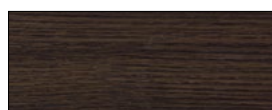

wengé 3167004



meranti 3162002

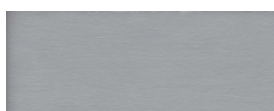

grigio chiaro 715505

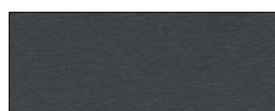

grigio antracite 701605



marrone cioccolato 887505



blu acciaio 515005

RIVESTIMENTO TIPO B

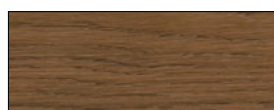

winchester 49240



teak 3241002



rosso scuro 300505



rosso chiaro 308105



grigio agata 703805

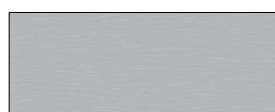

grigio luce 725105



nero opaco 4466062



argento 4361002



verde muschio 600505

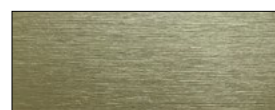

ottone 4361007



grigio quarzo 703905

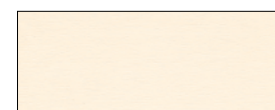

crema 137905



rovere zenzero 3078004



rovere sbiancato 3241306

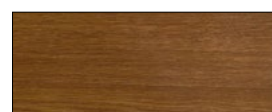

rovere miele 3078007

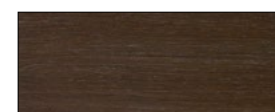

rovere amaranto 3078008

HST DESIGN TOP TERMIC . Colori

COLORI ACRYLCOLOR



grigio ardesia RAL 7015



grigio antraciate RAL 7016



grigio chiaro RAL 7040



grigio quarzo RAL 7039

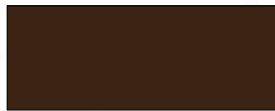

marrone seppia RAL 8014



nero intenso RAL 9005

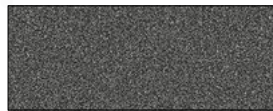

grigio scuro metal. DB703

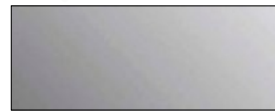

silver RAL 9007