



ALZANTE SCORREVOLE

HST SPAZIO DESIGN

Può un unico infisso unire bellezza estetica ed efficiente isolamento termico? La risposta a questa domanda è HST Brillat Spazio Design, scorrevole alzante con profilo a vista ridotto del 50% per una maggiore luminosità e un design moderno.



Maggiore luminosità



Design esclusivo



Ottimo isolamento termico e acustico

TRASMITTANZA TERMICA

NODO MEDIO (Uf) **1,30 W/m² K**

CARATTERISTICHE TECNICHE

- Profilo a vista ridotto del 50% per una maggiore luminosità e un design moderno
- Rinforzi in acciaio zincato in massa di spessore adeguato e di notevoli dimensioni
- Vetrocamera certificati ad alto isolamento termico ed acustico con canalina Warm-Edge
- Adatto al montaggio di vetri tripli fino a 44 mm di spessore
- Vasta gamma di colori e finiture
- Prodotto 100% Made in Italy



VERIFICHE a cui è stato sottoposto il sistema

ALZANTE SCORREVOLE
**HST SPAZIO
DESIGN**

VERIFICA

Verifica di idoneità in conformità a
RAL-GZ-716-1

Verifica isolamento termico

RISULTATO DELLA VERIFICA

Permeabilità all'aria conforme a
DIN EN 12207: classe 4

Resistenza alla pioggia battente conforme a
DIN EN 12208: classe 9A

Coefficiente di trasmittanza termica
Valore Uf medio = 1,30 W/m²K

NODI

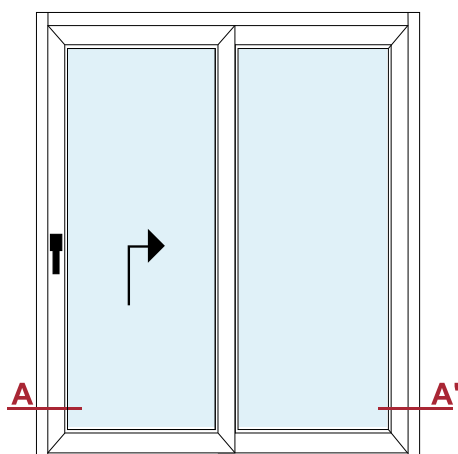

Sezione A-A'

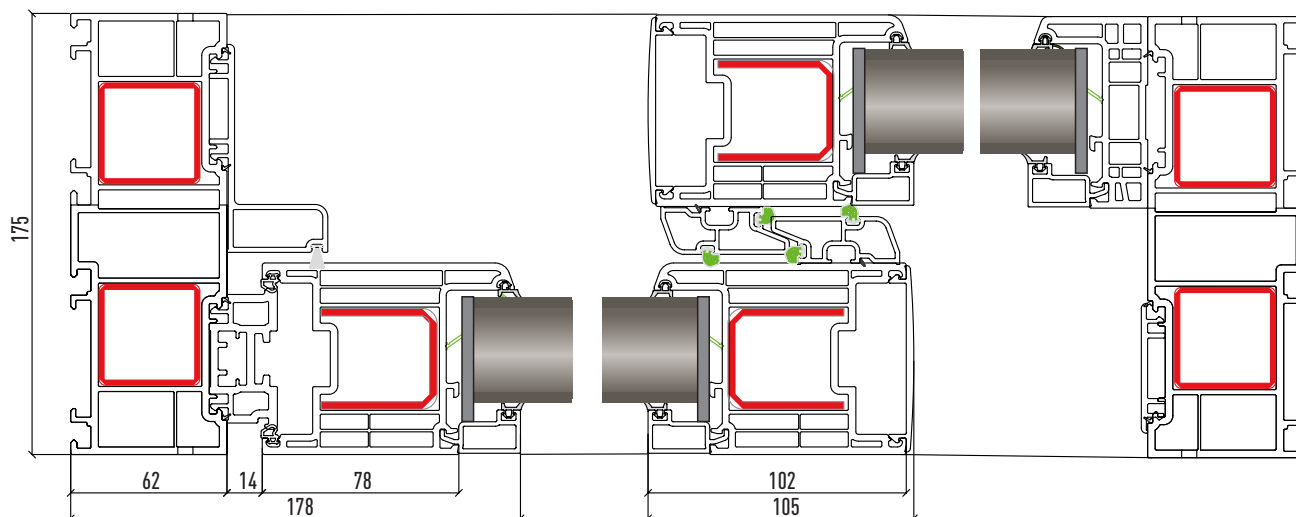

Scala 1:3

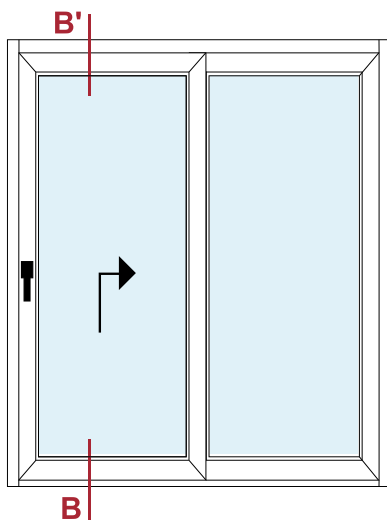

Sezione B-B'

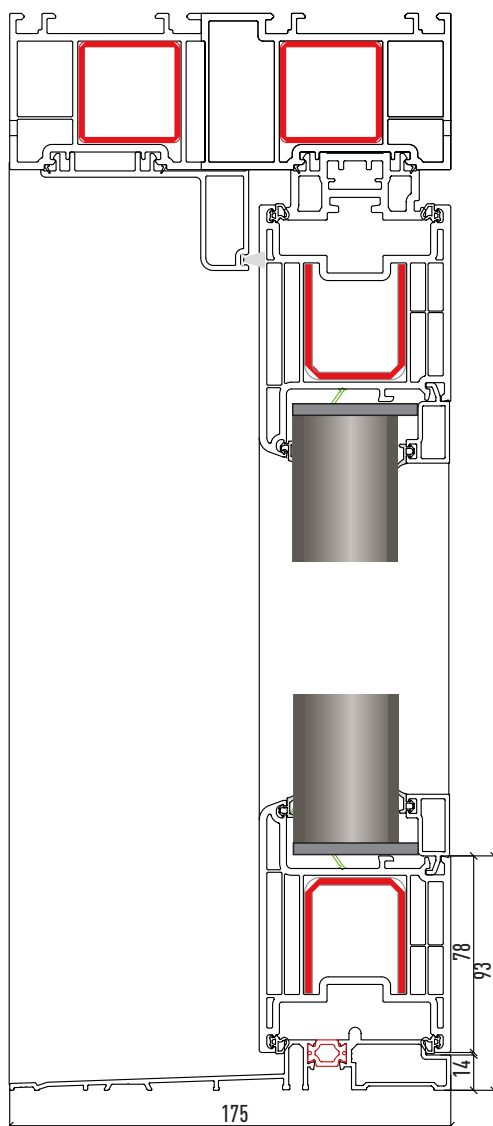

COLORI MASSA



Bianco 3

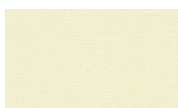

Avorio 096

RIVESTIMENTI TIPO A



Ciliegio 110

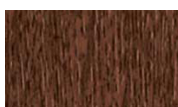

Noce 154



**Bianco classico
100**



Crema 96



**Cedro sbiancato
694**



Grigio Cedro 143



Grigio 004



Verde scuro 006



**Grigio Antracite
lucido 048**

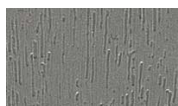

**Grigio Quarzo
068**



**Grigio Antracite
072**



Blu Acciaio 079



Winchester 109

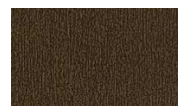

**Bronzo scuro
138**

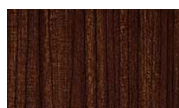

Macore 144



**Alluminio Grigio
184**

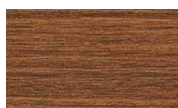

Douglas 402

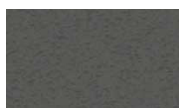

**Grigio Basalto
liscio 628**



Grigio liscio 651

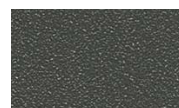

Alux DB703 653



**Noce Sorrento
Balsamico 663**



**Grigio Basalto
667**



**Grigio Antracite
Stylo 686**



**Nero Grafite
Stylo 690**



**Grigio Chiaro
907**



**Alluminio liscio
911**



**Alluminio Bianco
925**



**Marrone
cioccolato 008**

RIVESTIMENTI TIPO B



**Rosso scuro
027**



**Nero Grafite
Matt 043**

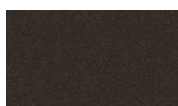

**Grigio Ombra
Matt 044**



**Woodec Turner
Oak Matt 047**



**Grigio Antracite
Matt 103**



**Bronzo
spazzolato 119**



**Verde Muschio
134**

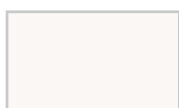

Bianco Matt 358



**Woodec Turner
Oak Toffee 342**



**Woodec Turner
Oak Walnut 346**



**Woodec Sheffield
Oak Concrete 036**



**Woodec Sheffield
Oak Alpine 042**